

LED Lighting Test Solution

www.chromaate.com

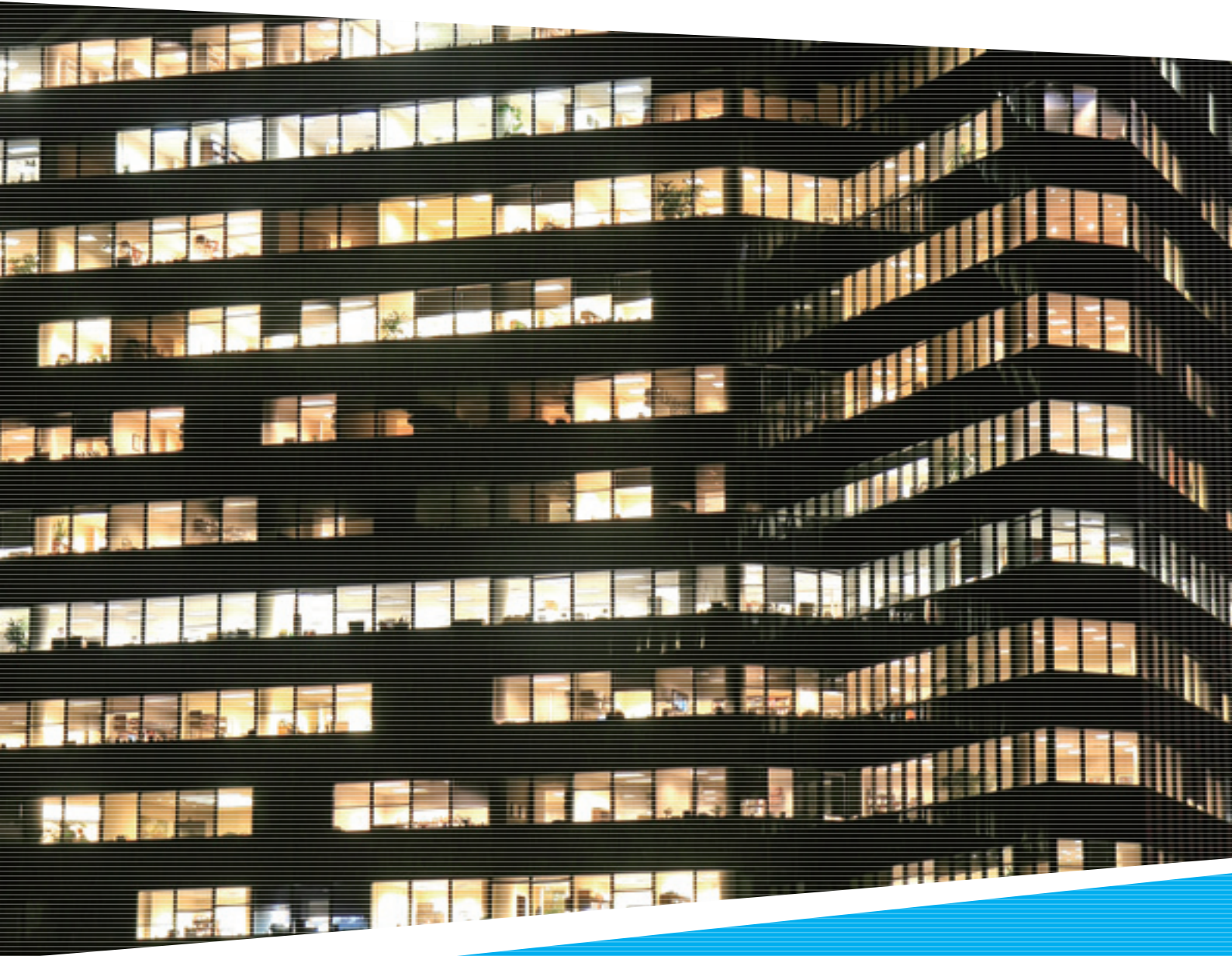

Chroma

Turnkey Test & Automation Solution Provider

Founded in 1984, **Chroma ATE Inc.** is a world leading supplier of precision Test and Measurement Instrumentation, Automated Test Systems, Manufacturing Execution Systems and Turnkey Test and Automation Solutions marketed globally under the brand name "Chroma".

Significant markets Chroma serves include LED, photovoltaic, Li-battery, electric vehicle (EV/EVSE), semiconductor/IC, laser diode, flat panel display, video and color, power electronics, passive component, electrical safety, and thermoelectric test, as well as automated optical inspection and manufacturing execution systems.

Chroma's vision is to develop globally leading products as a world-class enterprise. To achieve this, Chroma devotes a significant amount of investment and resources in research and development in order to produce exceptional products of precision, reliability and valuable unique test solutions for technology industries. To sustain as a world-class enterprise, Chroma nurtures its brand as one of innovation, continuous improvement, and globalization ensuring its leading technology and integration capabilities in optics, mechanics, electronics, thermal control and software provide competitive advantages and future growth for the company.

Chroma has branch offices in Europe, the United States, Japan and mainland China chartered to deliver innovative technologies with high value-added service to satisfy our global customers' demands.



Headquarters: Hwa-Ya Technology Park, Taiwan

Chroma Group & Global Operation Sites



CHROMA GROUP			
CHROMA ATE INC.			
Newworld H.K.	Chroma Investment	MAS Automation/Taiwan	Chroma New Material
Chroma/Beijing	Chroma/USA	MAS Automation/Nanjing	Testar Electronics
Chroma/Shanghai	Chroma/Netherlands	MAS Automation/Xiamen	ADIVIC Technology
Chroma/Suzhou	Chroma/Finland		ADLINK Technology
Chroma/Chongqing	Chroma/Japan		DynaScan Technology
Chroma/Xiamen			EVT Technology
Chroma/Shenzhen			
Chroma/Dongguan			

LED Burn-in Tester

Model 58266

Chroma 58266 is a LED Burn-in Tester that each channel can offer a constant current up to 500mA but also has 0~400V voltage measurement function. For product application, various programmable power supplies can be applied for multi-channel constant current output and voltage measurement. The user can integrate several power supplies based on the demands of channels and current for multi-channel test.

Key Features

- ✓ Flexible channels output: 32/64/128 channels
- ✓ Each channel can offer up to 500mA /400V
- ✓ Each channel can parallel connection for high current requirement. Ex: 2-ch: 1A, 4-ch: 2A
- ✓ High accuracy of current output and voltage measurement

System Architecture

- ✓ DUT: single LED, LED array, LED light bar or LED module
- ✓ Support channels: 64 ch
- ✓ Force Current: Max. 500mA per-channel
- ✓ Support parallel connection : Ex: 2-ch: 1A
- ✓ Voltage measurement: Max. 400V

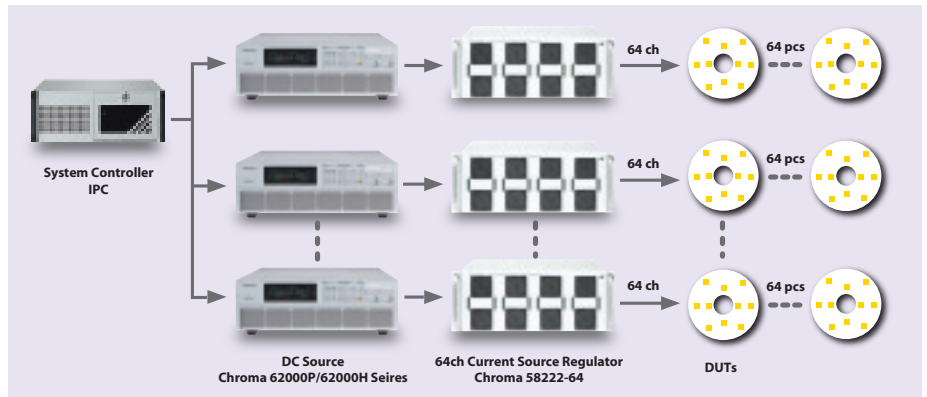

CONFIGURATION			
Programmable DC Power Supply	LED Burn-in Tester	Force I range	Measure V Range
Model 62012P-40-12 40V/120A/1200W	Model 58266	500mA 400mA	30V 35V
Model 62012P-100-50 100V/50A/1200W	Model 58266	500mA 170mA	32V 95V
Model 62024P-80-60 80V/60A/2400W	Model 58266	500mA 440mA	70V 75V
Model 62024P-100-50 100V/50A/2400W	Model 58266	500mA 350mA	70V 95V
Model 62024P-600-8 600V/8A/2400W	Model 58266	110mA 80mA	300V 400V
Model 62050P-100-100 100V/100A/5000W	Model 58266	500mA	95V
Model 62150H-450 450V/34A/15KW (380V/3 Φ 4W)	Model 58266	500mA	400V

SPECIFICATIONS				
Model	58222-64			
Electrical Specification				
Channels	64			
Force Current Range	1uA~ 10uA	10uA~ 100uA	100uA~ 100mA	100mA~ 500mA
Force Current Accuracy	±(0.3%+10nA)	±(0.3%+25nA)	±(0.3%+25uA)	±(0.3%+500uA)
Measure Voltage Range	0.1V~40V		40V~400V	
Measure Voltage Accuracy (2wires)	±(0.5%+5mV)		±(0.5%+10mV)	
Input Voltage limit *1	V input – V read<5V			
General Specification				
Interface	USB			
Operatoin Environment	Temperature: 0~55°C/Humidity:10~90%RH			
Temperature Coefficient	0~18°C & 28~55°C ±(0.3 x accuracy specification)/°C			
Weight (kg)	70			
Warm-up Duration	30 mins			

Note *1: The difference of DC output voltage and DUT read voltage is suggested to less 5V.



LED Lighting In-line Test System (For Production)

Model 58158-SC

The design concept of Chroma LED high speed measurement module is to combine several large size detectors and add up the luminous flux obtained by each detector to calculate the total flux of LED light. This design not only overcomes the shortcoming of previous inconvenient measurement for total flux by conventional integrating sphere, it also implements the inline test on production line. Chroma is able to provide the customer a fully automatic production line that covers both quality and productivity.

Key Features

- ☑ Mass production application: LED lamp, LED bulb, LED bar, LED streetlight, and other luminaries
- ☑ Less error comparing to integrating sphere measurement
- ☑ High speed test and flicker measurement
- ☑ Provide standard light source for calibration which is international standard traceable
- ☑ Thermal control fixture adaptable (option)

Test Items

- ☑ Optical Power characteristics : Lm, lm/w, LED operating frequency (Flicker)
- ☑ Color characteristics : CIE_{x,y}, Duv, CIEu'v', CCT, CRI
- ☑ Power characteristics : AC mode : Power factor (PF), I_{rms}, V_{rms}, THD
DC mode : Forward voltage



Instruments

Solar Cell Modules

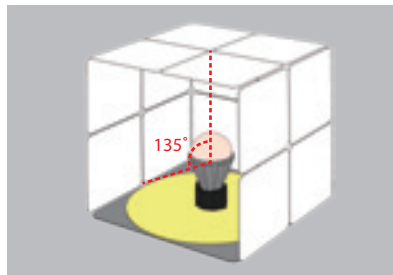
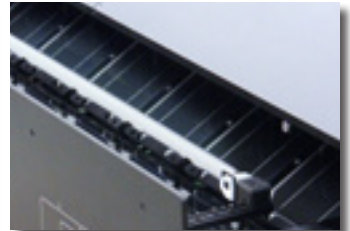

Solar Cell Module for Omnidirectional lamp

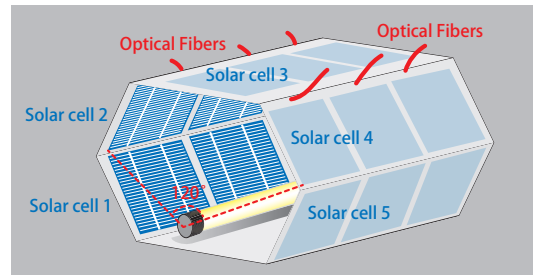

Solar Cell Module for JEL 801 LED Tube

In-line Production Test Applications

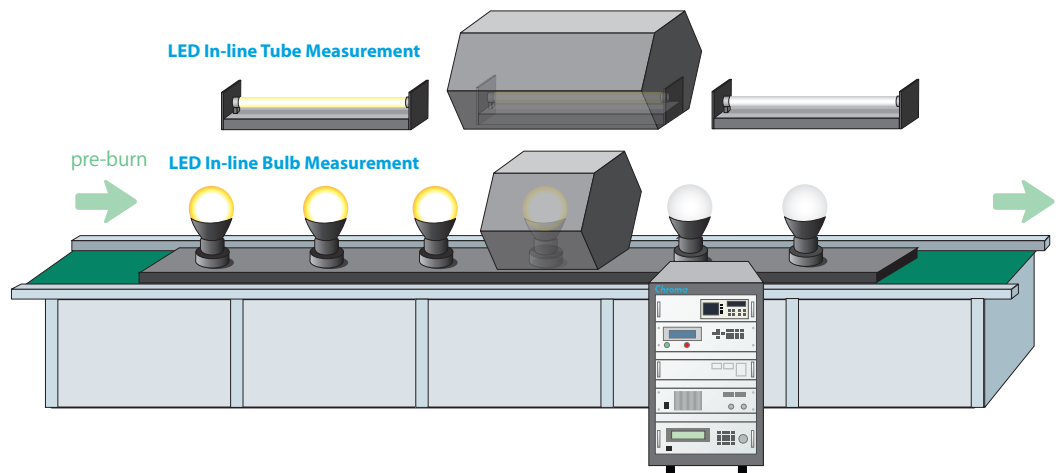

SPECIFICATIONS (25cm Integrating Sphere)		
Model		58158 -SC
Measurement Items		
Optical Measurement Items		Lumens (lm), CIE(x,y), CIE(u,v'), CCT, CRI
Electrical Measurement Items		Frequency, Real power P, power factor PF, THD (Option), Vf (Option)
Optical Measurement		
Photo Detector	Wavelength Range	380~780nm
	Lumens Range *1	<5,000 lm (>5K lm optional)
Spectrometer	Detector Type	2048 Pixels Linear CCD array
	Optical Fiber Connector	SMA 905
Lumen measurement Repeatability		± 2%
CIExy Repeatability *2		± 0.001
CCT Repeatability		± 30K @ 3000K
CRI Repeatability		± 0.1
Electrical AC Source		
Output Rating-AC		500VA
Voltage	Range/Phase	150V/300V/Auto
	Accuracy	0.2%+0.2%F.S.
	Resolution	0.1V
	Line Regulation	0.10%
	Load Regulation	0.20%
Max.Current / Phase	RMS	4A/2A (150V/300V)
	peak	24A/12A (150V/300V)
Electrical AC Meter		
Power	Range (W)	1.5W~1KW (Model 66201) ; 1.5W~10KW (Model 66202)
	Power Factor Accuracy *3	0.006+(0.003/PF)KHz
Harmonic	Range	2~50 order
DC Measurement (Optional)		
DC Power Supply	Output Voltage	0~64V (> 64V optional)
	Output Current	0~3A (> 3A Optional)
	Ripple and Noise	1400 uVrms & 14 mVp-p / < 1mA
	Line Regulation	0.01% +4mV / 0.01% + 300 μ A
	Load Regulation	< 6mV / 0.01% + 300 μ A
	Program Accuracy	0.02% + 10mV / 0.01%+1mA
Read back Accuracy		0.02% + 10mV / 0.01%+1mA
Others		
Dimension (H x W x D)		1081 x 532 x 700 mm
Weight		100k g
Power Consumption		300 W
Operating		100~240V VAC 50/60HZ
Software Support DC Source		
Chroma 6200P-300-8, Chroma 11200 (650V), Chroma 11200 (800V), Keithley 24XX Series		

Notes #1: 10inch Integrating Sphere without ND filter. Chroma also offers 12 and 20 inch integrating sphere for higher

Notes #2: The unit under test is 10W halogen lamp

Notes #3: The PF spec. applies only when the signals are higher then 50% of the selected voltage and current ranges

Analysis Tools



Power Analysis :
Im, Im/W, PF, Power

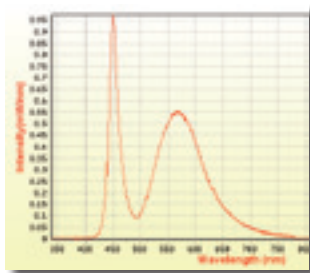

LED Spectrum Analysis :
CCT, CRI, Duv

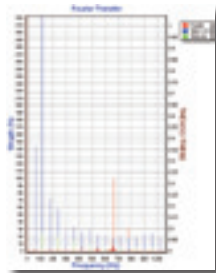

THD Analysis

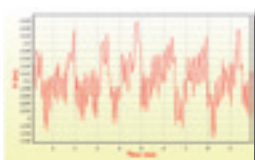

Flicker Analysis

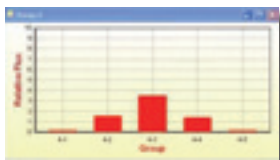

Flicker Analysis



LED Lighting Test System (For Laboratory)

Model 58158

Chroma 58158 LED Lighting Test System, compliances the AC LED Device National Standard, has integrated Chroma's Power Electronics Test Equipment - Programmable AC Power Source and Digital Power Meter to offer users a real AC environment for measuring AC LED.

Furthermore, the 58158 also integrates Chroma DC Power Supplies with the flexible optical test platform which equips with integrating sphere, photo detector, and etc.. Users can measure optical and electrical parameters of AC/DC LED through a friendly software interface.

Key Features

- ✓ Simulate the real AC test condition and environment
- ✓ Integrate AC, DC, and optical features test to one platform
- ✓ Support DC test for AC LED
- ✓ Support dual-optical test module in one platform (Integrating sphere or average intensity) (optional)
- ✓ Support AC /DC LIV Analysis
- ✓ Offer standard light source for calibration

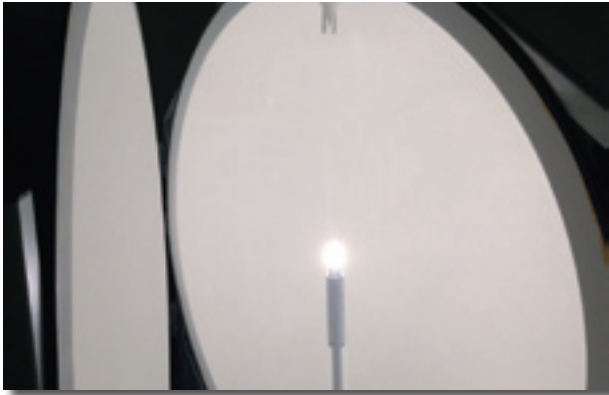
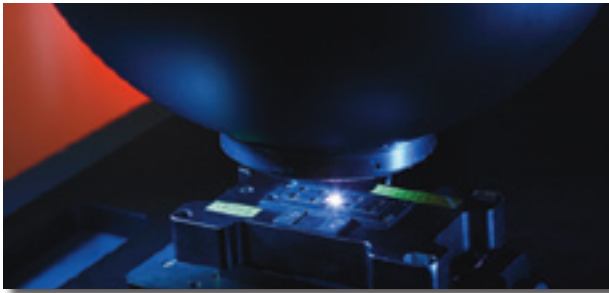

For Laboratory Test



Optional Integrating Spheres

SPECIFICATIONS			
Model		58158	
Measurement Items			
Optical Measurement Items		Lumens (lm), CIE(x,y), CIE(u',v'), CCT, CRI	
Electrical Measurement Items		Frequency, Real power P, power factor PF, THD (Option), Vf (Option)	
Optical Measurement			
Photo Detector	Wavelength Range	380~780nm	
	Lumens Range *1	<5,000 lm (>5K lm optional)	
Spectrometer	Detector Type	2048 Pixels Linear CCD array (optional)	
	Optical Fiber Connector	SMA 905	
Lumen accuracy		± 5%	
CIExy accuracy		± 0.004	
Lumen Repeatability		± 2%	
CIExy Repeatability *2		± 0.001	
Electrical AC Source			
Output Rating-AC		500VA	
Voltage	Range/Phase	150V/300V/Auto	
	Accuracy	0.2%+0.2%F.S.	
	Resolution	0.1V	
	Line Regulation	0.10%	
	Load Regulation	0.20%	
Max.Current / Phase	RMS	4A/2A (150V/300V)	
	peak	24A/12A (150V/300V)	
Electrical AC Meter			
Power	Range (W)	1.5W~1KW (Model 66201) ; 1.5W~10KW (Model 66202)	
	Power Factor Accuracy *3	0.006+(0.003/PF)KHZ	
Harmonic	Range	2~50 order	
DC Measurement (Optional)			
DC Power Supply	Output Voltage	0~64V (> 64V optional)	
	Output Current	0~3A (> 3A Optional)	
	Ripple and Noise	1400 uVrms & 14 mVp-p / < 1mA	
	Line Regulation	0.01% +4mV / 0.01% + 300 μ A	
	Load Regulation	< 6mV / 0.01% + 300 μ A	
	Program Accuracy	0.02% + 10mV / 0.01%+1mA	
	Read back Accuracy	0.02% + 10mV / 0.01%+1mA	
Others			
Dimension (H x W x D)		1081 x 532 x 700 mm	
Weight		100k g	
Power Consumption		300 W	
Operating		100~240V VAC 50/60HZ	
Software Support DC Source			
Chroma 6200P-300-8, Chroma 11200 (650V), Chroma 11200 (800V), Keithley 24XX Series			

Notes *1: 20 inch Integrating Sphere without ND filter.

Notes *2 : The unit under test is 10W halogen lamp

Notes *3 : The PF spec. applies only when the signals are higher than 50% of the selected voltage and current ranges

ORDERING INFORMATION			
Optical Module	50cm integrating sphere	1m integrating sphere	2m integrating sphere
Luminaire	small lamp, bulb, MR-16	middle lamp, 2 feet T8/T5 tube	large lamp, 4 feet T8/T5 tube, street light
Application	laboratory	laboratory	laboratory

Note : Customization for 3m integrating sphere



LED Light Bar Test System

Model 58182

Chroma 58182 LED Light Bar Test System is a fully automatic test system able to measure the top-view/side-view light bar uniformity composed of white light or RGB LED. With image recognition function, it can accurately capture the location of LED and identify the center of LED under the measurement. With automatic mechanical and optical measurement function, the 58182 can perform extremely accurate optical and electrical measurement.

The 58182 integrates image recognition function, automatic mechanical and optical measurement. It can not only improve the yield rate by sifting out the defect products, but also reduce the product verification time and development cost. In addition, the 58182 has a flexible measurement platform to adapt different type of top-view / side-view LED light bar measurement, and friendly user interface to reduce user's learning time. Consequently, the 58182 is the best choice for testing top-view/side-view light bar.

Key Features

- ✓ Measure the top-view/side-view light bar uniformity composed of white light or RGB LED
- ✓ Equipped with image recognition function to capture the LED location accurately
- ✓ Excellent optical performance
- ✓ ESD damaged sorting function
- ✓ FPC/PCB light bar adaptability

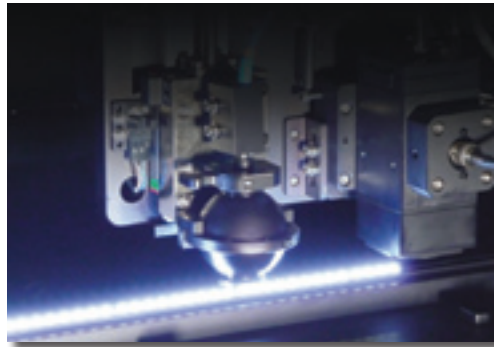

CIE127 Partial Flux Measurement Module



CIE127 Condition B measurement Module

SPECIFICATIONS

Model		58182		
Optical Module		CIE 127 condition B optical tube		
Average Intensive (mcd)	Range	100~10000mcd		
	Accuracy	± 5%		
	Repeatability	± 2%		
Lumen (lm) Measurement Specification		Option		
CIE x, y	Accuracy	± 0.004		
	Repeatability	± 0.002		
Spectrometer	Wavelength Range	380~780nm		
	Optical resolution	2nm		
	A/D	16 bits		
Light Bar length		600mm		
Offer Channels		20 X 12 Ch		
Power Supply	Voltage	0~200V	0~60V	0~300V
	Current	10uA~5mA	1mA~2A	40mA~2A
	Voltage accuracy	0.3%+0.1%F.S	0.01%+10mV	0.05%+0.05%F.S
	Current accuracy	0.3%+0.1%F.S	0.01%+1mA	0.03%+40mA
Data output	Format	Excel (*.csv)		
	Output items	mcd, CIEx, CIEy		
XY moving range		600x250mm		
Dimension		1300 (D) × 2360 (W) × 1815 (H)mm		

LED Light Bar Electrical Test System

Model 58183

Chroma 58183 is a PC base test system for LED light bar electrical test. In hardware design, Chroma 58183 not only offers a accurately current (10uA~5mA) to test LED electrical features but also can integrate an extra high power supply for high current test. Otherwise, Chroma 58183 offers multi-channels test function. It is widely used in many application. In LED light bar manufactory, 58183 can test more 10 pieces Light bar at the one time. In LED backlight manufactory, 58183 can test 4 pieces LED backlight via a 4 channels control box. To sum up, 58183 is a very strong and powerful tool for LED light bar and LED backlight manufactories.

Key Features

- ☑ Integrating customer's extened power supply
- ☑ PC base design
- ☑ Support multi- channels test
- ☑ Using general DUT adapter to offer test application widely
- ☑ Software support authority management



SPECIFICATIONS			
Model		58183	
System specifications			
Power supply	Output voltage	1~200V	
	Output current	10μA~5mA *1	
Program Accuracy	Voltage Range	1~200V	
	Voatage Accuracy	± 0.3% ± 0.2% FS	
	Current Range	100μA / 5mA	
	Current Compliance	± 5% ± 0.2% FS	
Applicative Type	Top / Side-view LED light bar		
Dimension (D x W x H)	IPC 418 x 330 x 175 , RelayBox 430 x 276 x 102 mm		
Weight	18 Kg(IPC 13Kg, RelayBox 5Kg)		
Electrical measurement specifications			
Testing condition		2 wires	
Voltage	Accruacy (1~200V)	± 0.3% ± 0.2% FS	
	Resolution	50mV	
RelayBox specifications(Not in live wire)			
	Ch1~24	Ch25~32	
Switch voltage	200VDC	300VDC	
Carry current	300mA	600mA	
Life expectancy of mechanical	10 ⁶	10 ⁶	
Power IN			
IPC	110 / 220V,50~60Hz, 7 / 3.5A		
RelayBox	110 / 220V,50~60Hz,2A		
Others			
General purpose relay	32 Channels		
Operation environment	Temperature:10~40°C ; Humidity:10%~70%		

Note*1 : Specifications not contain AUX Power, need to check relaybox loss if use AUX Power.



LED Electrical Test Module

Model 58221-200-2

Chroma 58221-200-2 is a module specially designed to test the electrical features of LED in full range. It has all functions required for testing the LED electrical features. The 58221-200-2 supplies high accuracy current source up to $\pm 200V/\pm 100mA$ for High voltage (HV) and up to $\pm 10V/\pm 2A$ for High Power (HP). Besides the standalone operation the 58222-200-2 is featured in, the USB interface and other integrated design can also be applied for synchronous measurement.

H.V. **H.P.**



Key Features

- ✓ Focuses on LED test application
- ✓ Cover High Voltage (HV) and High Power (HP) LED test requirement
- ✓ Build-in hardware sequencer
- ✓ Build-in program memory and data memory
- ✓ Support LED SCR characteristic detect function

Test items

- ✓ Forward voltage (Vf)
- ✓ Reverse breakdown voltage (Vrb) Leakage (Ir)
- ✓ LIV
- ✓ I-V characterization

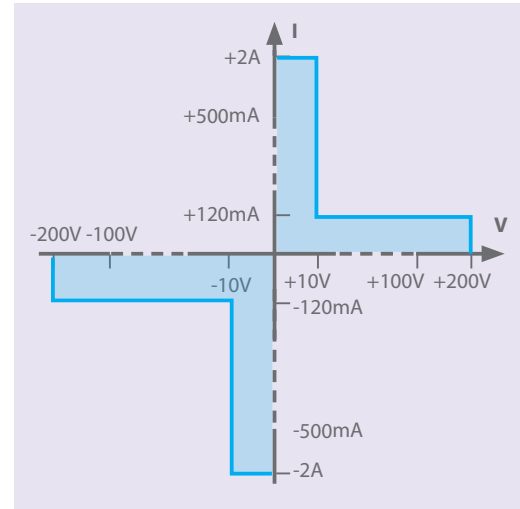

Wide voltage/current test range

SPECIFICATIONS				
Model	58221-200-2			
Current Source Accuracy $23 \pm 5^\circ\text{C}$				
Range	Programming Resolution	Source Accuracy ($\pm\%$ rdg.+Amps)	Default Measurement Resolution	Measurement Accuracy ($\pm\%$ rdg.+Amps)
$\pm 20 \mu\text{A}$	1nA	0.08%+5nA	1nA	0.06%+5nA
$\pm 500 \mu\text{A}$	10nA	0.08%+125nA	10nA	0.06%+125nA
$\pm 20\text{mA}$	1 μA	0.08%+5 μA	1 μA	0.06%+5 μA
$\pm 500\text{mA}$	10 μA	0.1%+125mA	10 μA	0.25%+125mA
$\pm 2\text{A}$	100 μA	0.1%+5mA	100 μA	0.25%+5mA
Voltage Source Accuracy				
Range	Programming Resolution	Source Accuracy ($\pm\%$ rdg.+Volts)	Default Measurement Resolution	Measurement Accuracy ($\pm\%$ rdg.+Volts)
$\pm 10\text{V}$	1mV	0.08%+3mV	1mV	0.06%+3mV
$\pm 100\text{V}$	10mV	0.08%+15mV	10mV	0.06%+15mV
$\pm 200\text{V}$	10mV	0.08%+30mV	10mV	0.06%+30mV
General Specification				
Interface	USB/Stand alone			
Trigger	Available			
RAM (6 bits)	16M			
Operatoin Environment	0~50°C, 70% R.H. up to 35°C, derate 3% R.H. / °C, 35~50°C			
Power Consumption (VA)	70VA			
Dimensions (WxHxD)	432x110x432 mm			
Weight (kg)	10			

ESD Test System



Model 58154 Series

Chroma 58154 series ESD (Electrostatic Discharge) Test Systems are PXI/PCI controlled module to simulate electrostatic discharge pulse during electronic device testing. The 58154 series offer both ESD STM5.1-2001-Human Body Model and ESD STM5.2-1999-Machine Model. The user friendly software offers programmable and flexible features, such as sampling test on a wafer, ESD model, ESD pulse polarity, ESD pulse interval in a sequence, and automatic testing function.

The 58154 series includes a control module and a pulse output external box. High voltage power supply unit (PSU) and pulse shaping circuits provide the ESD STM standards compliant pulse waveform.

The 58154 series offer a flexible and total ESD test solution to customers. Furthermore, the ESD pulse is generally applied to the device under test before measuring device electric parameters and the 58154 series can be perfectly integrated with Chroma 58173 and 58173-FC to provide a total solution in production line.

Key Features

- ✓ Two Modes ESD Pulse Generation : Human body mode and Machine mode
- ✓ Programmable Auto Test : Pulse delay, cycle and polarity are programmable
- ✓ Resolution (58154) :
 - 5V per-step for Machine model, 20V per-step for Human body mode
- ✓ Resolution (58154-B) :
 - 10V per-step for Machine model, 20V per-step for Machine mode,
 - 30V per-step for Human body mode
- ✓ Resolution (58154-C) :
 - 10V per-step for Machine model, 30V per-step for Human body mode
- ✓ Diversity Control Interface : PCI DIO card
- ✓ Up to 8000V (58154-C)



ESD Test System (PCI Board)

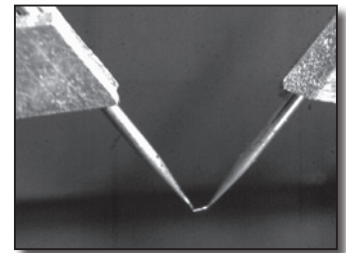

ESD Test on LED chip

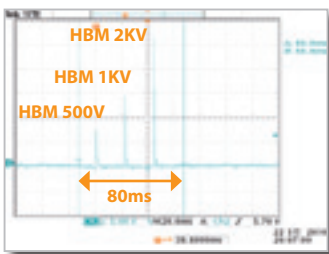

New Function and improvement -
3 HBM pulses within 80 ms

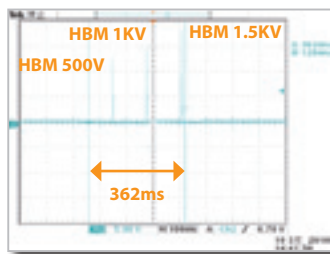

Traditional way -
3 HBM pulses within 362 ms

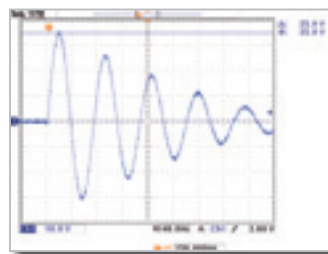

Machine Model waveform

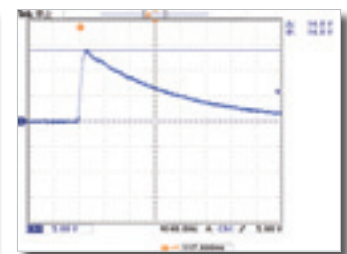

Human Body Model waveform

SPECIFICATIONS			
Model	58154	58154-B	58154-C
Parameter	Value		
ESD Mode	Machine Mode / Human body mode		
Pulse Voltage	Machine mode: 50V to 400V ± 5V Human body mode: 500V to 4KV ± 20V	Machine mode: 100V to 800V ± 10V Human body mode: 250V to 6KV ± 30V	Machine mode: 100V to 800V ± 10V Human body mode: 250V to 8KV ± 30V
ESD Specification *1	Machine model reference on STM5.2-1999 Human body model reference on STM5.1-2001		
Pulse Interval	20 ms to 1 s (User definable)		
Pulse Repetition	Single or multiple		
Pulse Polarity	Positive or negative (software control)		
AC Input	100 to 240V, 47 to 63 Hz		
Dimensions	434.6mm(W) x 97.7mm(H) x 306.8mm(D)		
Weight	11kg		

Pattern No: 95137265

Pattern Name: Discharge and remote feedback integrated testing system

Note*1 : The test condition is under output terminal of equipment



LED Flip Chip Total Power Test System

Model 58173-FC

Chroma 58173-FC is specifically designed for flip-chip LED, in which the probing surface is opposite to the light emitting surface, thus having a no-interference optical path while still having stable probing is the key factor to make an accurate measurement.

The 58173-FC's transparent chuck design (figure 1) features in no vacuum holes within the testing area, ensuring no interference along the optical path for all chips, and providing a solid stage for probing, thus it makes the measurement much more accurate.

The 58173-FC also applies Chroma's innovative total power measurement method (figure2), which collects more LED partial flux than the conventional probers, and that also improves the speed and accuracy significantly. Benefited from Chroma's innovative unique optical and mechanical design, most of the LED output radiant flux are received by a wide photo detector. Other optical parameters, such as dominant wavelength, peak wavelength, CCT, etc. are measured by Chroma's spectrometer.

In addition, Chroma58173-FC is equipped with a wide-range electrical source and meter, so that Chroma 58173-FC not only fits your requirements today, but also foresees and provides the solution for your next generation requirements.

Key Features

- ☑ Unique vacuum-hole-free chuck design
- ☑ Wide LED electrical test range (200V/2A)
- ☑ Support LED SCR characteristic detect function
- ☑ Chroma Huge Photo Detector (Measurement Angle=148°)
- ☑ Unique Edge Sensor design to provide stable probing
- ☑ Robust chip position scanning algorithm, suitable for various DUT forms
- ☑ Light shield design to block other light interference
- ☑ Comprehensive analysis tool and statistic report for mass production

Hardwares

- ☑ Semi-automatic prober for flip-chip LED
- ☑ Electrical test module
- ☑ Optical test module
- ☑ Optional ESD test module

Test items

- ☑ Electrical parameters: Forward voltage, reverse breakdown voltage, reverse leakage current, etc.
- ☑ SCR characteristic detection
- ☑ Total optical power, total flux
- ☑ Wavelength related: dominant wavelength, peak wavelength, FWHM, etc.



No vacuum hole design in transparent chuck

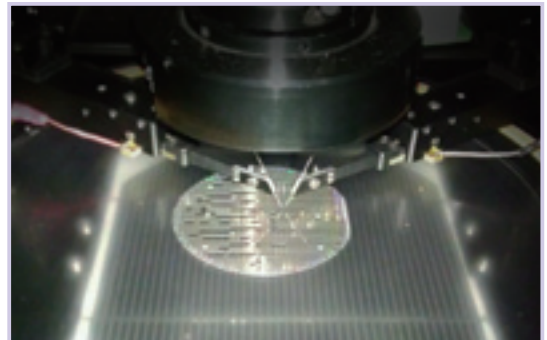

Figure 1 - Chuck with no vacuum holes that makes the measurement more accurate.

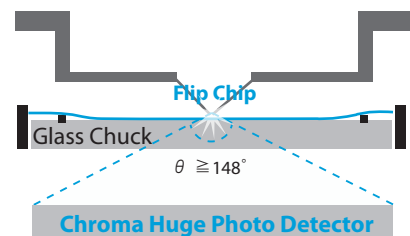
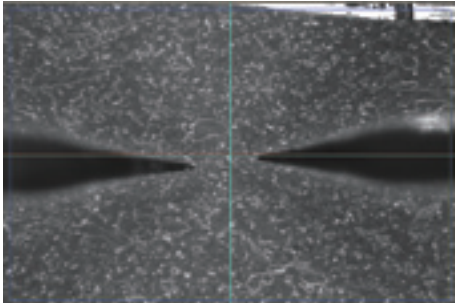

Figure 2 - Chroma's Innovative Method of LED Flip Chip Total Flux Measurement by Huge Photo Detector



Powerful Scanning Algorithm



User-friendly on screen pin adjustment

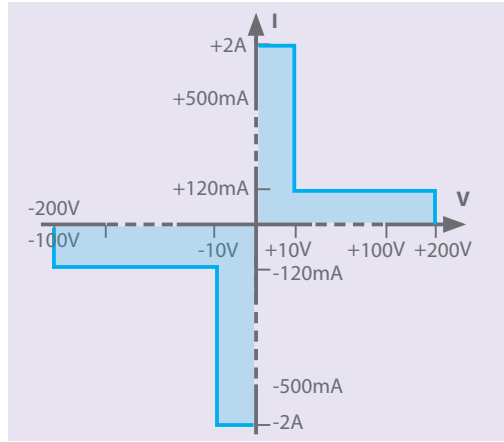

Wide voltage/current test range

SPECIFICATIONS		
Model		58173-FC
Application		
Die Size		7~120mil
Pad Size		$\geq 70 \mu\text{m}$
Chuck Size		5.3 inch For Extended Ring / 7.3 inch For Extended Ring / 10 inch For Extended Ring
Maximum Optical Receiving Angle		$148^\circ *1$
Electrical Parameter Measurements		
PowerRange		$\leq 20\text{W}$, as figure shows
Voltage	Source Range	$\pm 10\text{V} / \pm 100\text{V} / \pm 200\text{V}$
	Source Accuracy	$\pm 0.08\% + 10\text{mV} / \pm 0.08\% + 20\text{mV} / \pm 0.08\% + 40\text{mV} *2$
	Measure Range	$\pm 10\text{V} / \pm 100\text{V} / \pm 200\text{V}$
	Measure Accuracy	$\pm 0.06\% + 10\text{mV} / \pm 0.06\% + 20\text{mV} / \pm 0.06\% + 40\text{mV} *2$
Current	Source Range	$\pm 20\mu\text{A} / \pm 500\mu\text{A} / \pm 20\text{mA} / \pm 500\text{mA} / \pm 2\text{A}$
	Source Accuracy	$\pm 0.08\% + 10\text{nA} / \pm 0.08\% + 300\text{nA} / \pm 0.08\% + 10\mu\text{A} / \pm 0.3\% + 1\text{mA} / \pm 0.3\% + 12\text{mA} *2$
	Measure Range	$\pm 20\mu\text{A} / \pm 500\mu\text{A} / \pm 20\text{mA} / \pm 500\text{mA} / \pm 2\text{A}$
	Measure Accuracy	$\pm 0.06\% + 10\text{nA} / \pm 0.06\% + 300\text{nA} / \pm 0.06\% + 10\mu\text{A} / \pm 0.25\% + 1\text{mA} / \pm 0.25\% + 12\text{mA} *2$
SCR Test Function		Yes
Optical Parameter Measurements		
Spectrometer	Detector Type	2048 Pixels
	Wavelength range	380~780nm (standard)
	Pixel Resolution	0.4nm
Wp	Repeatability	$\pm 1 \text{ nm}$
Wd	Repeatability	$\pm 0.3 \text{ nm}$
Radiant Flux (mW)	Detector Type	Chroma [®] Huge Photo Detector
	Range	3W Max.
	Repeatability	$\pm 3\%$
Mechanical Specifications		
Glass Chuck Size		5.3 inch For Extended Ring / 7.3 inch For Extended Ring / 10 inch For Extended Ring
Scan CCD		Resolution 1024X768 Pixel
θ axis		$\pm 12^\circ$
Dimension		970 (L) \times 970 (W) \times 2250 (H) mm
Weight		580 kg
Others		
Operation Environment	Temperature	$20^\circ\text{C} \sim 30^\circ\text{C}$
	Humidity	40% ~ 70%
Power Input		220V

Note *1 : LED dies distribution diameter after extention has to be smaller than 3" / 5" / 8"

Note *2 : Test condition is under point of sensing



LED Total Power Test System

Model 58173

Chroma 58173 comes with an unique design and a whole new method for LED total power measurement. In bare wafer/chip LED test production, due to the existence of probing mechanism, total flux is derived from partial flux measurement in LED epitaxy industry (Figure 1). However, the conventional method encounters problems and issues in measurement accuracy, S/N ratio, measurement speed, etc. All of these are serious concerns in production line.

Chroma has developed a high speed and high accuracy measurement method for LED total power/flux (Figure 2). This innovative test method may collect most of the optical power emitted from LED, much more than the conventional one. Thus applying this test method may improve the measurement accuracy dramatically and significantly. Benefited from Chroma's innovative unique optical and mechanical design, most of the LED output radiant flux are received by a wide photo detector. Other optical parameters, such as dominant wavelength, peak wavelength, CCT, etc. are measured by Chroma's spectrometer.

In addition, the 58173 is equipped with a wide-range electrical source and meter, so that the 58173 not only fits your requirements today, but also foresees and provides the solution for next generation requirements.

Key Features

- ☑ Wide LED electrical test range (200V/2A)
- ☑ Support LED SCR characteristic detect function
- ☑ Chroma Huge Photo Detector (Measurement Angle=128°)
- ☑ Unique Edge Sensor design to provide stable probing
- ☑ Robust chip position scanning algorithm, suitable for various DUT forms
- ☑ Light shield design to block other light interference
- ☑ Comprehensive analysis tool and statistic report for mass production

Hardwares

- ☑ Semi-automatic LED wafer/chips prober
- ☑ Electrical test module
- ☑ Optical test module
- ☑ Optional ESD test module

Test items

- ☑ Electrical parameters : Forward voltage, reverse breakdown voltage, reverse leakage current, etc.
- ☑ SCR characteristic detection
- ☑ Total optical power, total flux
- ☑ Wavelength related : dominant wavelength, peak wavelength, FWHM, etc.

Standard Optical Module

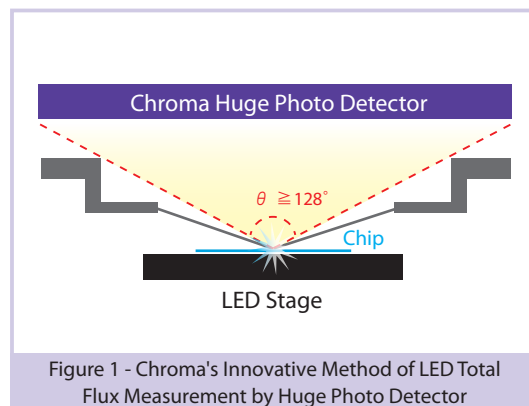

Optional Optical Modules

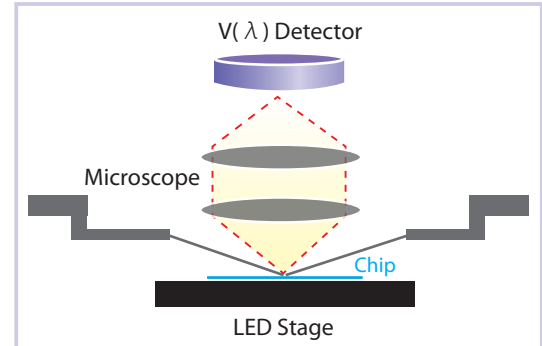
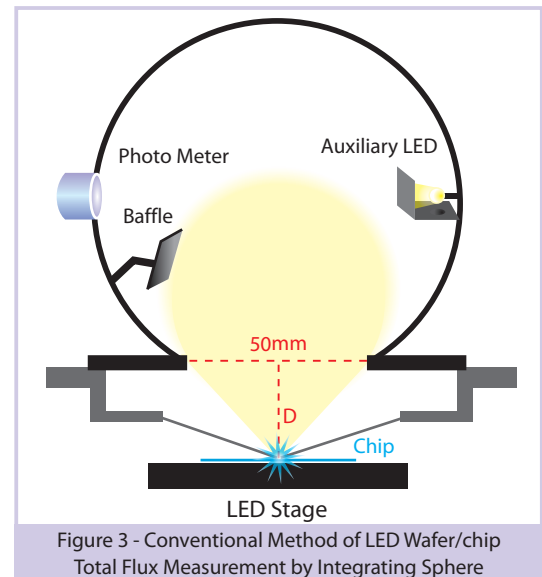
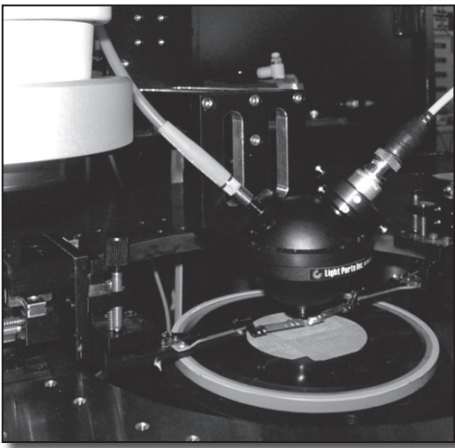
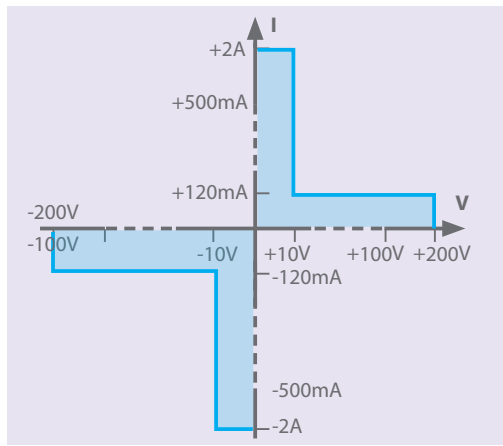

Figure 2 - Conventional Method of LED Wafer/chip Total Flux Measurement by Microscope Module





Integrating Sphere



Wide voltage/current test range

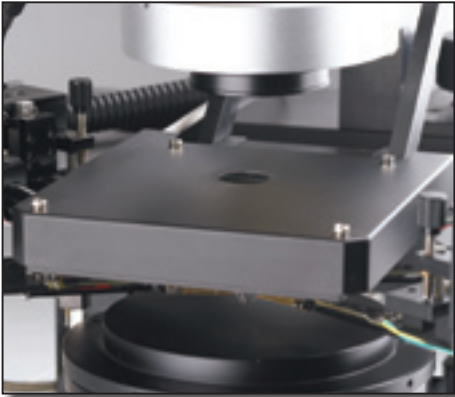

Chroma® Huge Photo Detector

SPECIFICATIONS		
Model		58173
Application		
Pad Size		≥ 70 μm
Maximum Optical Receiving Angle		128°
Electrical Parameter Measurements		
Power Range		≤ 20W, as figure shows
Voltage	Source Range	± 10V / ± 100V / ± 200V
	Source Accuracy	± 0.08% + 10mV / ± 0.08% + 20mV / ± 0.08% + 40mV Note1
	Measure Range	± 10V / ± 100V / ± 200V
	Measure Accuracy	± 0.06% + 10mV / ± 0.06% + 20mV / ± 0.06% + 40mV Note1
Current	Source Range	± 20uA / ± 500uA / ± 20mA / ± 500mA / ± 2A
	Source Accuracy	± 0.08% + 10nA / ± 0.08% + 300nA / ± 0.08% + 10uA / ± 0.3% + 1mA / ± 0.3% + 12mA *1
	Measure Range	± 20uA / ± 500uA / ± 20mA / ± 500mA / ± 2A
	Measure Accuracy	± 0.06% + 10nA / ± 0.06% + 300nA / ± 0.06% + 10uA / ± 0.25% + 1mA / ± 0.25% + 12mA *1
SCR Test Function		Yes
Optical Parameter Measurements		
Spectrometer	Detector Type	2048 Pixels
	Wavelength range	380~780nm (standard)
	Pixel Resolution	0.4nm
Wp	Repeatability	± 1 nm
Wd	Repeatability	± 0.3 nm
Radiant Flux (mW)	Detector Type	Chroma® Huge Photo Detector
	Range	3W Max.
	Repeatability	± 3%
Mechanical Specifications		
Scan CCD		Resolution 1024X768 Pixel Gray scale CCD (256 scales)
θ axis		± 15°
Dimension		970 (L) × 970 (W) × 2250 (H)mm
Weight		580kg
Others		
Operation Environment	Temperature	20°C~ 30°C
	Humidity	40% ~ 70%
Power Input		220V

Note *1: Test condition is under point of sensing



instrumentos de medida

SEPTIEMBRE, 31 28022 MADRID

TEL. 91 300 01 91

www.idm-instrumentos.es

idm@idm-instrumentos.es

Chroma

HEADQUARTERS

CHROMA ATE INC.

T +886-3-327-9999

F +886-3-327-8898

info@chromaate.com

www.chromaate.com

CHINA

CHROMA ELECTRONICS (SHENZHEN) CO., LTD.

T +86-755-2664-4598

F +86-755-2641-9620

JAPAN

CHROMA JAPAN CORP.

T +81-45-542-1118

F +81-45-542-1080

www.chroma.co.jp

U.S.A.

CHROMA SYSTEMS SOLUTIONS, INC.

T +1-949-600-6400

F +1-949-600-6401

sales@chromausa.com

www.chromausa.com

CHROMA ATE INC. (U.S.A.)

T +1-949-421-0355

F +1-949-421-0353

Toll Free +1-800-478-2026

info@chromaus.com

www.chromaus.com

EUROPE

CHROMA ATE EUROPE B.V.

T +31-318-648282

F +31-318-648288

sales@chromaeu.com

www.chromaeu.com