

Digital I/O board, optically isolated, 64 digital inputs and outputs, 24 V, for PCI Express

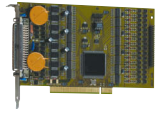

Also for **PCI**
See APCL-1564, page 162

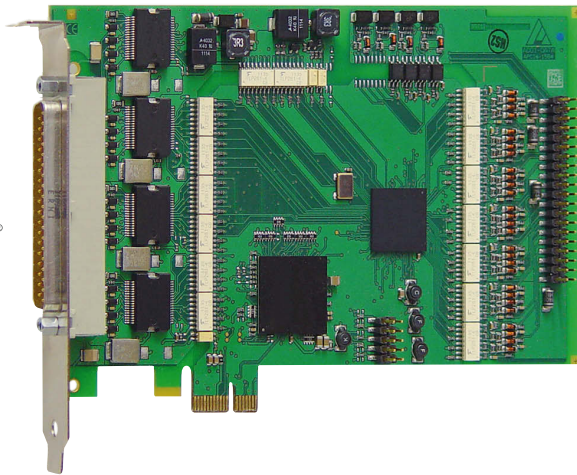

on request



LabVIEW™
on request

Features

Inputs

- 32 optically isolated inputs, 24 V, incl. 16 interruptible inputs
- Channels 0–2 can be used as 32-bit counter inputs (up to 500 kHz)
- Reverse voltage protection
- All inputs are filtered

Outputs

- 32 optically isolated outputs, 11 to 36 V
- Output current per channel 500 mA
- Total current: 3 A typ. (fused through PTC resistor)
- Watchdog for resetting the outputs to "0"
- At Power-On, reset of the outputs to "0"
- Current limit: ~1.5 A per 8 channels (through PTC)
- Short-circuit current per output ~1.5 A typ.
- Self-resetting fuse (electronic fuse)
- Overtemperature and overvoltage protection
- 24 V power outputs with protection diodes and filters
- Ext. 24 V voltage supply screened and filtered
- Shutdown logic, when the external supply voltage drops below 7 V

Timer / Watchdog / Counter

- 2 timers (12-bit), of which one can be used as a watchdog
- 3 counter (32-bit)

Safety features

- Optical isolation 1000 V
- Creeping distance IEC 61010-1
- Protection against fast transients (burst), overvoltage, electrostatic discharge and high-frequency EMI
- Separate ground line for inputs and outputs

Protective circuit for the input channels

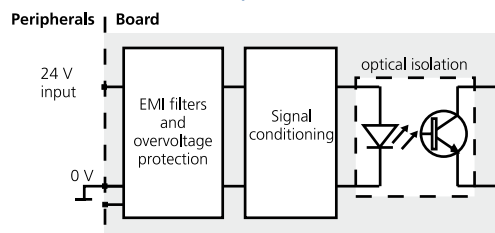

APCL-1564

PCI Express interface

32 digital inputs, 24 V,
including 16 interruptible inputs

32 digital outputs, 24 V, 500 mA/channel

Optical isolation 1000 V

Input and output filters

Connection through industry-standard
D-Sub connector

Applications

- Industrial I/O control
- PLC coupling
- Signal switching
- Interface to electromechanical relays
- Automatic test equipment
- ON/OFF monitoring of motors, lights...
- Watchdog timer
- ...

Software drivers

A CD-ROM with the following software and programming samples is supplied with the board.

Standard drivers for:

- Linux
- 32-bit drivers for Windows 8 / 7 / Vista / XP / 2000
- Signed 64-bit drivers for Windows 8 / 7 / XP
- Real-time use with Linux and Windows on request

Drivers and samples for the following compilers and software packages:

- C#.NET, C

On request:

Further operating systems, compilers and samples.

Driver download: www.addi-data.com/downloads

Protective circuit for the output channels

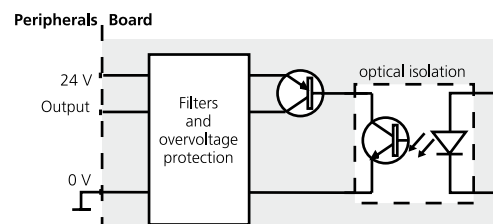

* Preliminary
product information

Specifications*

Digital inputs

Number of inputs: (common ground acc. to IEC 1131-2)	32 digital inputs, channel 0-2 can be used as 32-bit counter inputs (up to 500 kHz)
Interruptible inputs:	16 channels (channel 4 to 19)
Optical isolation:	1000 V through opto-couplers, from PC to peripheral
Nominal voltage:	24 V
Input current:	Channel 0-3: 6.6 mA at 24 V, typical Channel 4-31: 2 mA at 24 V, typical
Input frequency (max.):	Channel 0-2: 500 kHz at 24 V Channel 3-31: 5 kHz at 24 V
Logic input levels:	UH (max.): 30 V / 3.1 mA, typical (channel 4-31) UH (min.): 19 V / 1 mA, typical (channel 4-31) UH (max.): 30 V / 11 mA, typical (channel 0-3) UH (min.): 19 V / 3.4 mA, typical (channel 0-3) UL (max.): 14 V / 0.1 mA, typical UL (min.): 0 V / 0 mA, typical
Filters/protective circuit:	Input filters, transil diode, RC filters, Z diode, opto-couplers

Digital outputs

Number of outputs:	32 digital outputs
Output type:	High-side (load to ground) acc. to IEC 1131-2
Optical isolation:	1000 V (through opto-couplers), from PC to peripheral
Nominal voltage:	24 V
Supply voltage range:	11 to 36 V
Current limit:	1.5 A per 8 channels (through PTC)
Output current per output:	500 mA (typical)
Short-circuit current per output:	1.5 A (typ.) pulse current shutdown at 24 V, $R_{load} < 0.1 \Omega$
RDS ON resistance:	0.2 Ω at 25 °C
Switch-on time:	$t_{out} = 0.5 A$, load = resistance: 50 μs
Switch-off time:	$t_{out} = 0.5 A$, load = resistance: 75 μs
Overtemperature (shutdown):	135 °C (output driver)
Temperature hysteresis:	15 °C (output driver)

Timer/watchdog

Timer:	2 x 12-bit, 1 x programmable as watchdog from 1 μs to 4095 s
--------	---

Safety

Shutdown logic (V_{CC} diagnostic):	When the ext. 24 V voltage drops below 7 V, the outputs are switched off.
Watchdog:	For resetting the outputs to "0"
Common diagnostics:	For all 16 channels at overtemperature of one channel

EMC – Electromagnetic compatibility

The product complies with the European EMC directive. The tests were carried out by a certified EMC laboratory in accordance with the norm from the EN 61326 series (IEC 61326). The limit values as set out by the European EMC directive for an industrial environment are complied with. The respective EMC test report is available on request.

Physical and environmental conditions

Dimensions:	168 x 99 mm
System bus:	Acc. to PCI Express base specification, Revision 1.0a (PCI Express 1.0a)
Space required:	1-/4-/8-/16-lane PCI Express slot
Operating voltage:	+ 3.3 V from PC
Current consumption:	Inputs and outputs inactive 340 mA $\pm 10 \%$, typical inputs and outputs active 590 mA $\pm 10 \%$, typical
Front connector:	37-pin D-Sub male connector
Temperature range:	0 to 60 °C (with forced cooling)

Simplified block diagram

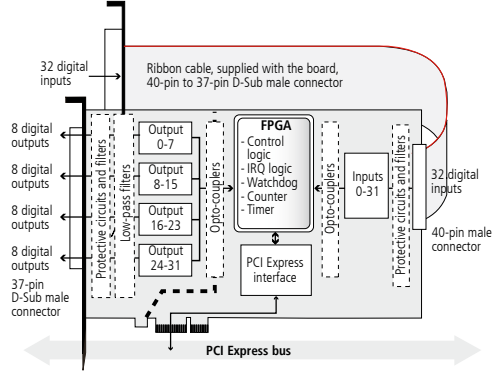

Pin assignment – 37-pin D-Sub male connector

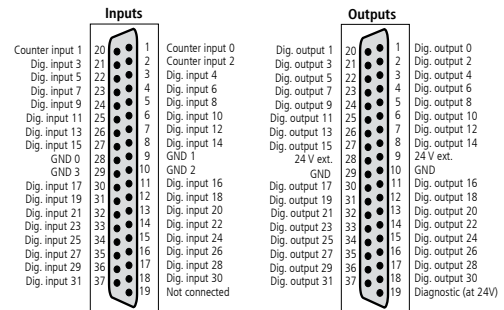

ADDI-DATA connection

Example 1:

- Connection of the inputs (Ribbon cable)
- Connection of the outputs through screw terminal panel PX901-DG or PX9000

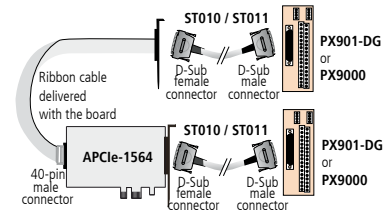

Example 2:

- Connection of the outputs with relay output board PX8500-G cascaded in 32 relays

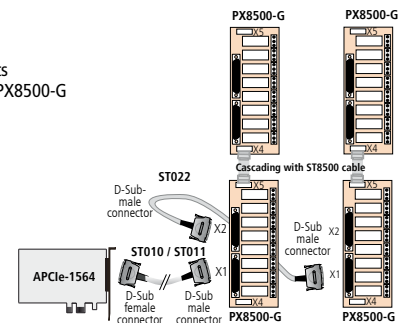

Ordering information

ST010:	Standard round cable, shielded, twisted pairs, 2 m
ST011:	Standard round cable, shielded, twisted pairs, 5 m
ST010-S:	Same as ST010, for high currents
ST022:	Round cable between PX8500-G and PX901 or PX9000, shielded, 2 m
ST8500:	Ribbon cable for cascading two PX8500-G

*Preliminary product information