

Digital I/O board, optically isolated, 16 digital inputs and outputs, 24 V, for PCI Express

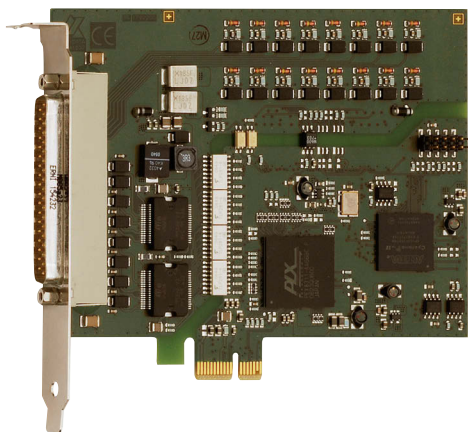

APCLe-1516

PCI Express interface

8 digital inputs, 24 V

8 digital outputs, 24 V, 500 mA/channel

Optical isolation 1000 V

Input and output filters

Connection through industry standard

D-Sub connector

Features

Inputs

- 8 optically isolated inputs, 24 V
- Reverse voltage protection
- All inputs are filtered

Outputs

- 8 optically isolated outputs, 11 to 36 V
- Output current per channel 500 mA
- Total current: 1.5 A typ. (fused through PTC resistor)
- Watchdog for resetting the outputs to "0"
- At Power-On, reset of the outputs to "0"
- Current limit: ~ 1.5 A per 8 channels (through PTC)
- Short-circuit current per output ~1.5 A typ.
- Self-resetting fuse (electronic fuse)
- Overtemperature and overvoltage protection
- 24 V power outputs with protection diodes and filters
- External 24 V voltage supply screened and filtered
- Shutdown logic, when the external supply voltage drops below 7 V

Safety features

- Optical isolation 1000 V
- Creeping distance IEC 61010-1
- Separate ground line for inputs and outputs
- Protection against fast transients (burst), overvoltage, electrostatic discharge and high-frequency EMI
- Watchdog for the outputs

Applications

- Industrial I/O control
- PLC coupling
- Signal switching
- Interface to electromechanical relays

Software drivers

A CD-ROM with the following software and programming samples is supplied with the board.

Standard drivers for:

- Linux
- 32-bit drivers for Windows 8 / 7 / Vista / XP / 2000
- Signed 64-bit drivers for Windows 8 / 7 / XP
- Real-time use with Linux and Windows on request

Drivers and samples for the following compilers and software packages:

- .NET
- Microsoft VC++ • Borland C++
- Visual Basic • Delphi
- LabVIEW • LabWindows/CVI

ADDIPACK functions:

- Digital input • Digital output • Watchdog

On request:

Further operating systems, compilers and samples.

Driver download: www.addi-data.com/downloads



Also for **PCI**
See APCI-1516, page 160



Windows
64/32-bit drivers



LabVIEW™



LabWindows/CVI™

Protective circuit for the input channels

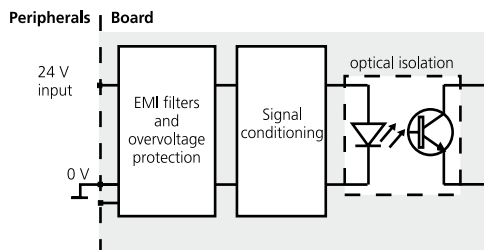

Protective circuit for the output channels

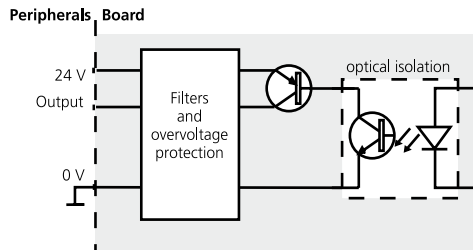

Specifications

Digital inputs

Number of inputs: (common ground acc. to IEC 1131-2)	8 digital inputs
Optical isolation:	1000 V through opto-couplers, from PC to peripheral
Nominal voltage:	24 V
Input current:	Channel 0-7: 2 mA at 24 V, typical
Input frequency (max.):	Channel 0-7: 5 kHz at 24 V
Logic input levels:	UH (max.): 30 V UH (min.): 19 V UL (max.): 14 V UL (min.): 0 V
Filters/protective circuit:	Input filters, transil diode, RC filters, Z diode, opto-couplers

Digital outputs

Number of outputs:	8 digital outputs
Output type:	High-side (load to ground) acc. to IEC 1131-2
Optical isolation:	1000 V (through opto-couplers), from PC to peripheral
Nominal voltage:	24 V
Supply voltage range:	11 to 36 V
Current limit:	1.5 A for all channels (through PTC)
Output current per output:	500 mA (typical)
Short-circuit current per output	1.5 A (typ.) pulse current shutdown at 24 V, $R_{load} < 0.1 \Omega$
RDS ON resistance:	max. 0.2 Ω at 25 °C
Switch-on time:	$t_{out}=0.5$ A, load = resistance: 50 μ s
Switch-off time:	$t_{out}=0.5$ A, load = resistance: 75 μ s
Overtemperature (shutdown):	135 °C (output driver)
Temperature hysteresis:	15 °C (output driver)

Safety

Shutdown logic (V_{CC} diagnostic):	When the ext. 24 V voltage drops below 7 V: The outputs are switched off.
Watchdog:	For resetting the outputs to "0" Time units: 1 up to 4095 μ s, ms, s
Diagnostics:	Common Diagnostics for all 8 channels at overtemperature of one channel

EMC – Electromagnetic compatibility

The product complies with the European EMC directive. The tests were carried out by a certified EMC laboratory in accordance with the norm from the EN 61326 series (IEC 61326). The limit values as set out by the European EMC directive for an industrial environment are complied with. The respective EMC test report is available on request.

Physical and environmental conditions

Dimensions:	149 x 99 mm
System bus:	Acc. to PCI Express base specification, Revision 1.0a (PCI Express 1.0a)
Space required:	1-/4-/8-/16-lane PCI Express slot
Operating voltage:	+ 3.3 V from PC
Current consumption:	Inputs and outputs inactive 320 mA \pm 10 %, typical 8 inputs and outputs active 400 mA \pm 10 %, typical
Front connector:	37-pin D-Sub male connector
Temperature range:	0 to 60 °C (with forced cooling)

Simplified block diagram

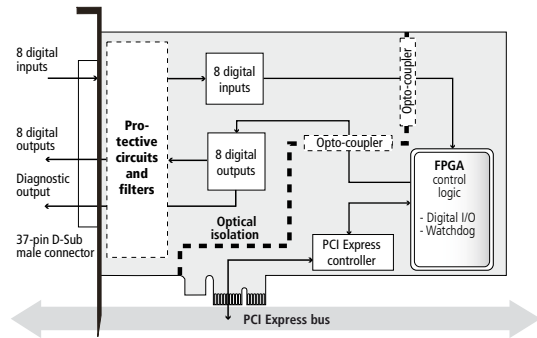

Pin assignment – 37-pin D-Sub male connector

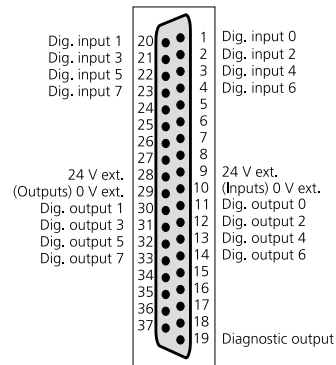

ADDI-DATA connection

Example 1
Connection of the inputs and outputs through screw terminal panel

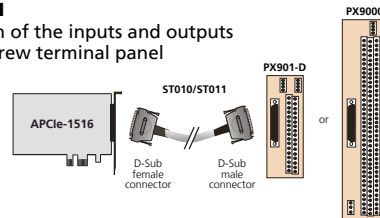

Example 2
Connection of the inputs through screw terminal panel PX901-DG

Connection of the outputs through relay output board PX8500-G

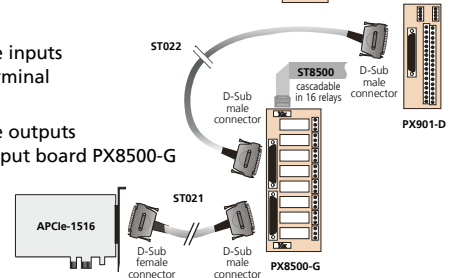

Ordering information

APcLe-1516

Digital I/O board, optically isolated, 16 digital inputs and outputs, 24 V, for PCI Express. Incl. technical description and software drivers.

Accessories

- PX901-D:** Screw terminal panel, LED status display
- PX901-DG:** Screw terminal panel, LED status display, for DIN rail
- PX9000:** 3-row screw terminal panel for DIN rail, with LED status display
- PX8500-G:** Relay output board for DIN rail, cascadable

- ST010:** Standard round cable, shielded, twisted pairs, 2 m
- ST011:** Standard round cable, shielded, twisted pairs, 5 m
- ST010-S:** Same as ST010, for high currents
- ST021:** Round cable between APcLe-1516 and PX8500-G, shielded, twisted pairs, 2 m
- ST022:** Round cable between PX8500-G and PX901 or PX9000, shielded, 2 m
- ST8500:** Ribbon cable for cascading two PX8500-G